

# CBC-1000 Series Loop Unidirectional Clutch/Brake Control System

## Installation & Operating Instructions

P-275  
819-0496



An Altra Industrial Motion Company

## Contents

Ordering Information . . . . .	2
Introduction . . . . .	2
Selection Procedures . . . . .	3
Specifications . . . . .	4
Dimensions . . . . .	4
Control Overview. . . . .	5
Operation. . . . .	6
Diagnostics Tests . . . . .	9
Programming. . . . .	10
Installation . . . . .	14
Applications. . . . .	18
Serial Interface. . . . .	20
Troubleshooting. . . . .	25
Warranty. . . . .	Back Page

## Ordering Information

Model Number	Part Number
CBC-1000. . . . .	6060-448-001
Encoder Cable (Accessory) . . . . .	6060-101-001
100 Pulse Per Revolution Encoder w/10' Cable . . . . .	6060-101-010
250 Pulse Per Revolution Encoder w/10' Cable . . . . .	6060-101-025
600 Pulse Per Revolution Encoder w/10' Cable . . . . .	6060-101-060
1200 Pulse Per Revolution encoder w/10' Cable . . . . .	6060-101-120
RS-232 to RS-422/485 Converter (Accessory) . . . . .	6060-101-232

**⚠ WARNING** Failure to follow these instructions may result in product damage, equipment damage, and serious or fatal injury to personnel.

## Introduction

Warner Electric's CBC-1000 is a closed-loop positioning control with error compensation designed for industrial clutch/brake applications. The position loop is closed through encoder feedback which generates pulses proportional to load motion. The CBC-1000 uses this feedback to determine the optimum brake actuation point. The control can be programmed to operate in one of two distinct modes: absolute or incremental. The CBC-1000 includes eight solid state control outputs, a batch counter and a serial communications interface.

The CBC-1000 system consists of four key elements: the CBC-1000, a clutch/brake, a clutch/brake control, and an encoder. Nearly any electric clutch/brake size and configuration can be used. These products are described in Warner Electric's Clutch/Brake Catalog, P-1234. The Clutch/ Brake control, also found in Warner Electric's Clutch/Brake Catalog, should have solid-state compatibility. Simple on-off, soft start/stop, and overexcitation controls may all be utilized based on the desired velocity profile. Warner Electric also offers industrial grade encoders of various resolutions.

## Addendum Sheet



Warner Electric LLC  
449 Gardner Street  
South Beloit, IL 61080  
tel 815-389-3771  
fax: 815-389-2582

### **CBC-1000AH Service and Installation Instructions Additions to P-275**

The CBC-1000AH Closed Loop Unidirectional Clutch/Brake Control System has had a feature addition and the current manual number P-275 does not reflect this addition. The added feature is the auto home capability (CBC-1000AH) which requires a marker input from the encoder to find its user defined home position which might be lost during a power loss condition. There are a few simple steps that should be followed to set up the CBC-1000AH properly.

1. Connect all the necessary components making sure the sig z wire (the marker pulse input) from the encoder goes to control input 11 (sig z/marker) on the CBC-1000AH. This input was previously labeled Continuous/Single.
2. After the encoder and the controls are installed and turned on, position the machine at home and reset the counter.
3. Rotate the machine until the 'ref' light to the left/bottom of the display lights up.
4. Record the number displayed on the counter when the 'ref' light is lit.
5. Enter the programming mode by pressing the RUN/PGM key on the front panel of the control and typing 1000. The number that you recorded should be put in programming line 1 (h, the home reference number). Subsequently, all the programming line numbers in the P-275 manual will be incremented by 1.
6. Every cycle when the CBC-1000AH sees the marker pulse the home reference number that was recorded will be loaded into the counter value on the front panel display. It is important that this value is as close as possible to what it should be. If more than ten cycles have occurred and your error is greater than +/- 15, you should decrease/increase respectively the home reference number.
7. After cycling approximately ten times observe your actual braking distance number (BRK DIS, key 8 on the front keypad) enter the programming mode and record this number in line 2 (bd, initial braking distance). Subtract the home reference number recorded in line 1 from the move preset (MOV PST, key 2 on the front keypad). This number must be greater than the actual braking distance number. If the braking distance number is larger, then the encoder needs to be rotated without the machine being rotated to change where the marker pulse occurs. Otherwise, the marker pulse will occur after the brake has come on and will not be detected.
8. Before exiting the program mode you will need to turn Count Retention off (CrEt, programming line 8). If count retention is left on and a power failure occurs while the system is in its braking mode when power is reapplied, it will take three cycles to find home.

The auto home feature will be very helpful when a power failure occurs and the encoder/control are unable to track position. When power is reapplied a remote start can be applied and the machine will rotate until the marker pulse is detected then the home reference number that was loaded in will be downloaded to the counter and CBC-1000AH will know its position and perform an accurate stop. The machine may miss its first home position if the power up position is past where the marker pulse occurs.

The CBC-1000AH is programmed to not allow any outputs to fire until a home reference number is entered. Also, depending on the speed of your system a lower resolution encoder may be needed to increase the length of the marker pulse so it can be properly detected. The encoder that has been sent is a 600ppr encoder. Therefore, your MOVE PRESET (key 2 on the front panel) needs to be changed to 600 if you are only moving one revolution per cycle.



**INDUSTRIAL MAGZA**  
DIST. AUTORIZADO

MEX (55) 53 63 23 31  
QRO (442) 1 95 72 60

MTY (81) 83 54 10 18  
ventas@industrialmagza.com

## Selection Procedures

### Select the Proper Clutch/Brake

Determine torque and inertia requirements.  
Calculate heat dissipation for required cycle rate.  
For best accuracy, mount clutch/brake directly on nip or drive shaft. Avoid backlash.

### Select Encoder (Quadrature)

Select encoder PPR for desired system resolution (i.e., inches/pulse, degrees/pulse. Determine input frequency; do not exceed 20 KHz (20,000 pulses/sec). Mount encoder directly to nip or drive shaft for best accuracy. Refer to Encoder Selection, page 7.

### Select Clutch/Brake Power Supply

Use CBC-700 overexcitation control for best accuracy. Use CBC-500/550 for soft starting and/or stopping. **Note:** Brake autogap may have to be removed for best accuracy. Refer to clutch/brake control, page 7.

### Plan System Logic (Switching Requirements)

Use absolute mode for indexing applications such as conveyors and turntables or cutoff applications where close registration is required. Use incremental mode for cutoff applications where close registration is required. Use incremental mode for cutoff applications. Refer to mode of operation, page 8. Determine switching and relays required for machine operation. Refer to pages 14-19 for specific wiring options. Examples of incremental and absolute wiring schematics are shown on pages 18 and 19.

### Calculate Scaling Factor

Reference display scaling, page 8, to scale the display to read inches, meters, degrees, rotations, etc.

### Determine Program Steps

Select absolute or incremental mode, output delays and other options. Refer to Programming Section, page 12.

## Serial Communications

For data collection or remote operation, refer to Serial Interface on pages 20-23.

## Specifications

<b>Part No.</b>	<b>6060-448-001</b>
<b>Input Power</b>	100 to 130 VAC, 50/60 Hz, 20VA (200 to 260 VAC selectable)
<b>Auxiliary Supply</b>	12 VDC @ 175 mA Used for powering encoder, etc.
<b>Main Counter</b>	
Range	6 Decade
Reset Input Operation	2 Individual with 6 decade range Quadrature
Reset Input	External and front panel
Count Rate	(20 kHz external input frequency)
<b>Batch Counter</b>	
Range	6 Decade
Presets	1 with 6 Decade range
Operation	Count UP by detecting Zero Speed
Reset	Through front panel only
Output	Latched, fixed to output terminal 21
<b>Signal A and B Inputs</b>	
Input Frequency	DC, 20 kHz quadrature max.
Input Type	Single ended, Current Source
Input Logic	Times 2
Input High Level	3.25 VDC min.
Input Low Level	1.75 VDC max.
Input Impedance	1.0Ω to common
Input current	3.25 mA steady state
Input Response	10 μs. min high and low time
<b>Control Inputs</b>	
Input Frequency	DC to 20 Hz max. each input
Input Type	Single ended, current sinking
Input Logic	Both Edge and Level sensitive as defined by input use
Input High Level	10 VDC min. to 20 VDC max.
Input Low Level	0 VDC min. to 2 VDC max.
Input Impedance	4.7Ω pullup to +12 VDC
Input Current	2.5 mA steady state
Input Response	25 ms. make and break time
<b>Display</b>	
Decade	7 Decade, 0.6" red LED
Decimal Point	User programmable Range: xxx.xxx to xxxxxx

<b>Keyboard</b>	Sealed tactile feel, 18 positions
<b>Program Security</b>	Program LOCK of lines 1 - 34
<b>Control Outputs</b>	
Type	8 Solid State, 100 mA sink max., 24 VDC max.
<b>Serial Interface</b>	
Type	RS-422A/485 compatible
Baud Rate	Selectable: 300, 600, 1200, 2400
Parity	Selectable: None, Odd, Even
Data	ASCII
Format	Start bit, 7 bit ASCII data, Parity bit, Stop bit
I.D. Number	Programmable 0 to 98: Allows multidrop systems
<b>Diagnostics</b>	
Test 0	Keyboard Test
Test 1	Non-Volatile RAM Test
Test 2	Input Test
Test 3	Output Test
Test 4	Display Test
Test 5	Program Memory Test
Test 6	Date Code Test
Test 7	Serial I/O Test
Test 8	Return to Factory Programming
<b>Mechanical</b>	
Enclosure	Aluminum extrusion with molded VALOX bezel. 2.91" high x 5.67" wide x 6.03" deep overall
Weight	2.5 lbs.
Cutout	5.43" ± 0.04" x 2.68" ± 0.03"
Panel Thickness	1/16" to 1/4"
Panel Depth	5.68" minimum
<b>Environmental</b>	
Operating Temp.	0° to +50°C (32° to 122°F)
Storage Temp.	-18° to 85°C (0° to 186°F)
Ambient Humidity	90% and noncondensing
<b>Controller Error Codes</b>	
Error 2: Low AC Line Voltage	
Error 3: Input Frequency too fast	
Error 4: Processor time fully utilized	



## Dimensions For Panel Mounting

Make panel cutout. Affix adhesive gasket (if required) to panel. Remove panel straps and slide unit thru cutout. Slide panel straps into enclosure guides. Thread 5/8" long hex washer head screws into guides using a 3/16" hex driver and tighten securely.

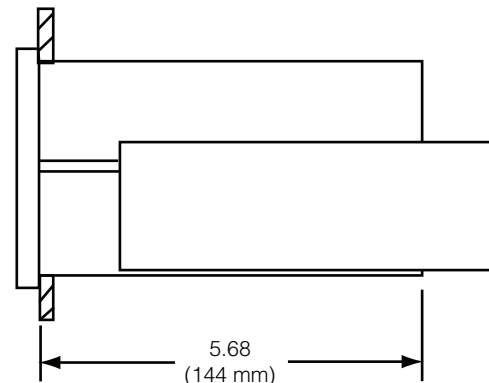
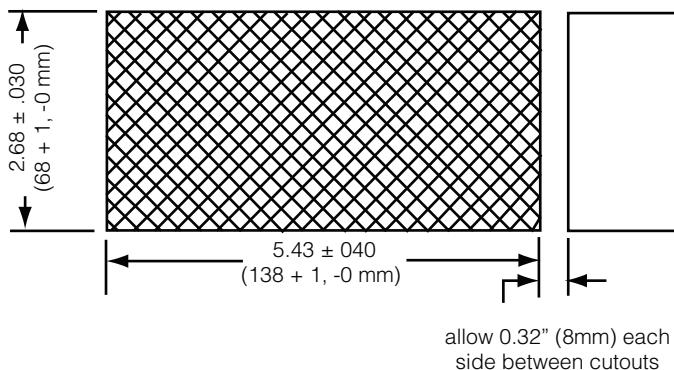

# Control Overview

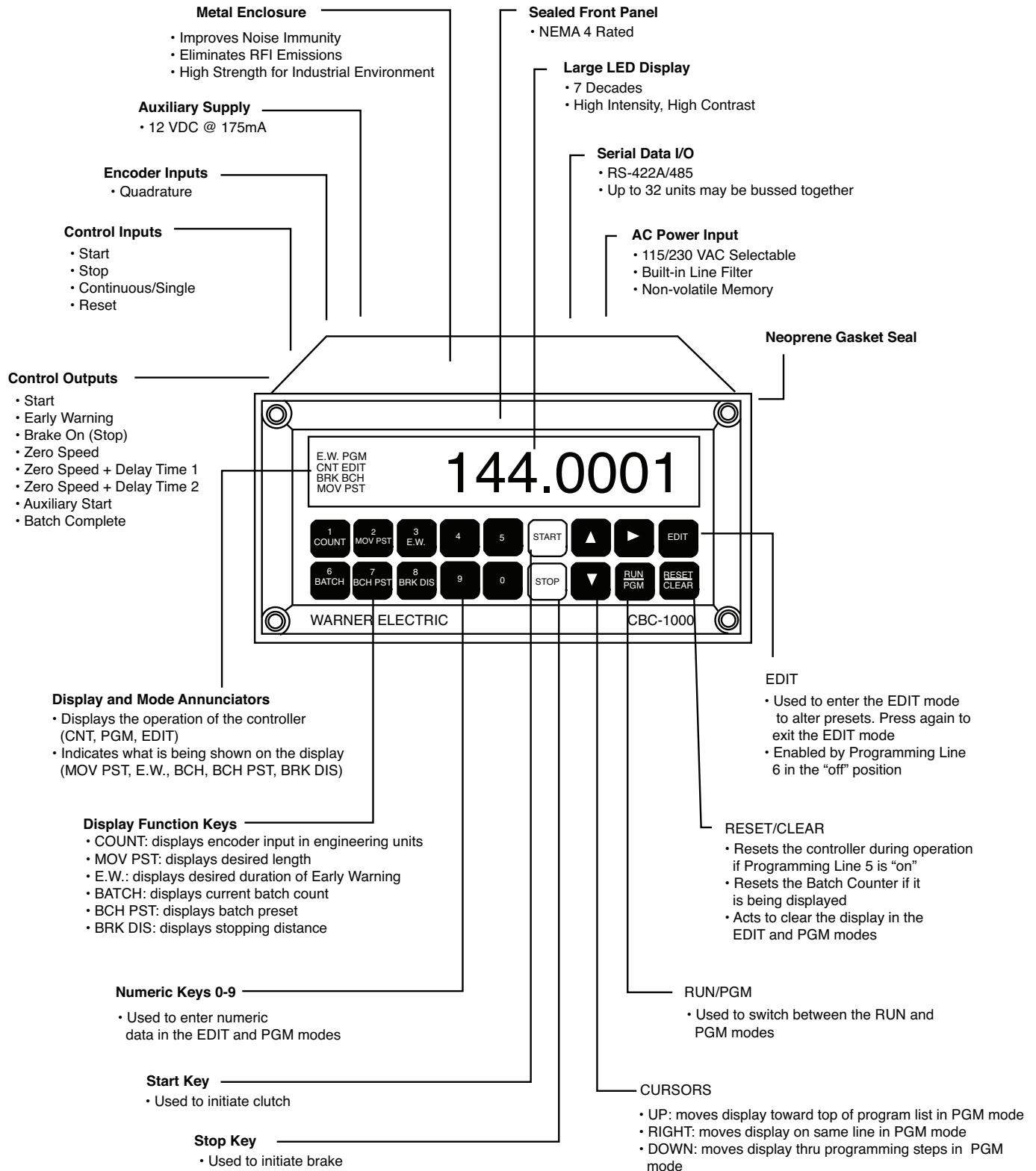

## Operation

Successful operation will require knowledge of the following definitions and their relationships to the timing diagram.

Function Key	Definitions
Count <span style="border: 1px solid black; border-radius: 50%; padding: 2px;">1 COUNT</span>	The actual move distance, in pulses or scaled into engineering units (inches, feet, rotations, degrees, etc.) displayed dynamically.
Move Preset <span style="border: 1px solid black; border-radius: 50%; padding: 2px;">2 MOV PST</span>	The desired move distance in pulses or scaled into engineering units. This is the value the operator enters to select a new move distance. It can also be locked during the RUN mode by simply programming line 6 to "off".
Early Warning <span style="border: 1px solid black; border-radius: 50%; padding: 2px;">3 E.W.</span>	A distance prior to Move Preset at which the early warning output is activated. Expressed as pulses or engineering units, this output can be used to accomplish a soft brake (slow down), energize valves, etc.
Batch <span style="border: 1px solid black; border-radius: 50%; padding: 2px;">6 BATCH</span>	A cumulative batch counter that can be dynamically displayed to show the number of operations, cycles, etc. When this counter reaches the value programmed by the Batch Preset (key 7) the Batch Complete Output (pin 21 on CBC-1000) is activated. The batch counter can be manually or automatically reset.
Batch Preset <span style="border: 1px solid black; border-radius: 50%; padding: 2px;">7 BCH PST</span>	A programmable batch counter activates the batch complete output when the value programmed has been reached by the batch (key 6).
Braking Distance <span style="border: 1px solid black; border-radius: 50%; padding: 2px;">8 BRK DIS</span>	The actual distance required to stop. This value is dynamically updated to determine the brake actuation point. Factory default is 25 pulses or engineering units which is only used for the first cycle after power-up. After the first cycle the CBC-1000 will tune to the braking distance required.

## Timing Diagram

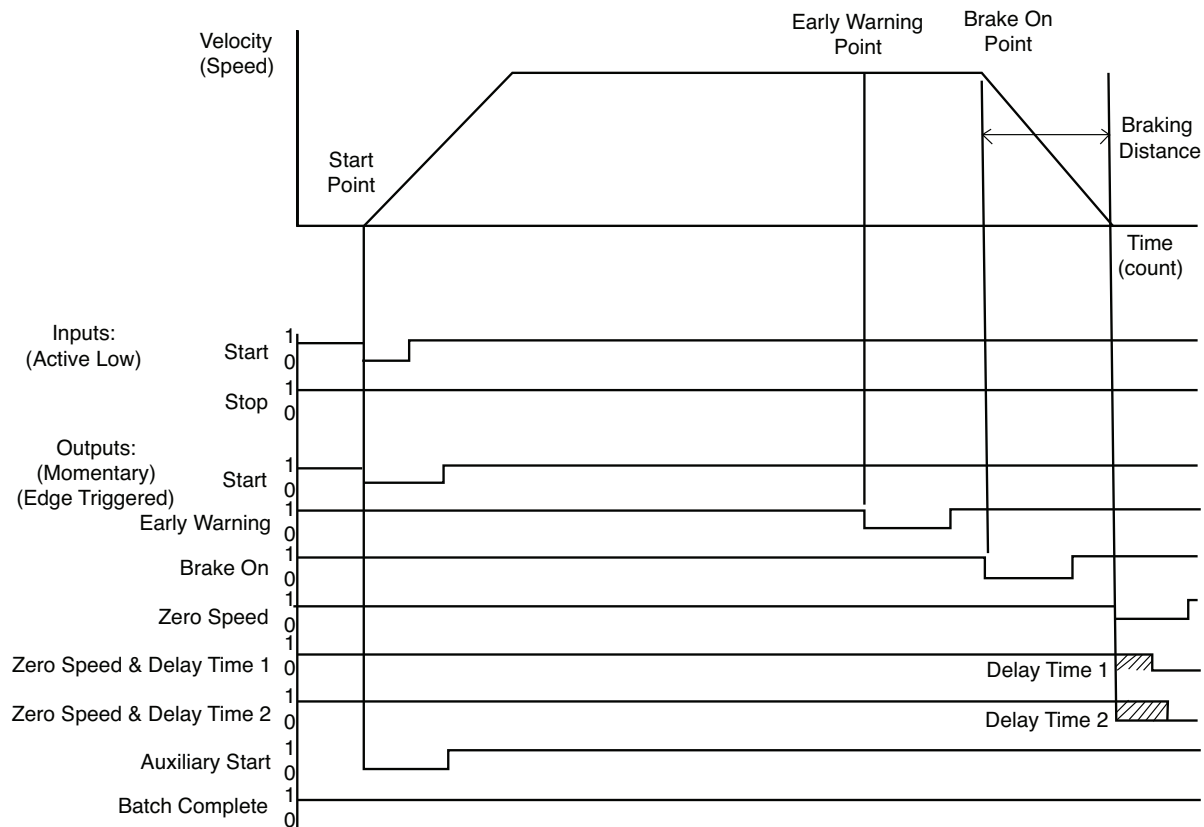



## Operation

The CBC-1000 system cycle to cycle accuracy will usually be plus or minus several encoder counts. Various factors can affect positional accuracy, the most significant of which are discussed below:

### Encoder Selection

- Type** - Only quadrature type encoders may be used.
- Location** - The encoder should be mounted as close as possible to the location where accuracy is desired, minimizing the effects of backlash and slippage. Direct mounting is preferred to indirect mounting.
- Resolution** - Encoder resolution should be maximized so the inherent plus or minus several count tolerance equates to the minimum linear or rotational inaccuracy. The product of encoder counts and rotational speed must be less than the input speed of 20,000 pulses per second (20kHz). The adjacent table simplifies selection:

- System Resolution** - Can also be increased by mechanical means. For example, decreasing the diameter of a nip roll connected to the encoder will increase system resolution.

The maximum encoder resolution at any operation speed is:

$$\frac{1}{\text{RPM}} \times 20,000 \times 60 = \text{Max. PPR}$$

Encoder Speed (RPM)	Encoder Resolution (pulses/rev.)
12,000 - 4,801	100
4,800 - 2,001	250
2,000 - 1,001	600
1,000 - 0	1200
480 - 0	2500
240 - 0	5000

## Clutch/Brake Control

Various velocity profiles may be achieved by properly selecting the clutch/brake control. These can generally be classified as overexcitation, on-off, and soft start/stop as depicted by the profiles below. These are shown in order of decreasing system accuracy. Accompanying each diagram are the recommended clutch/brake controls per given classification. The control should have solid-state switching. This will reduce unnecessary time delays inherent in electromechanical or mechanical switching devices. In addition, the system will not require external components such as relays, etc.

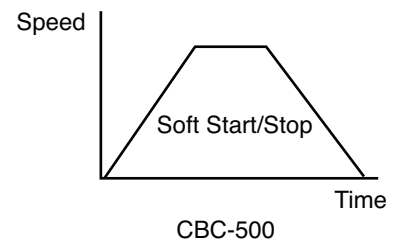
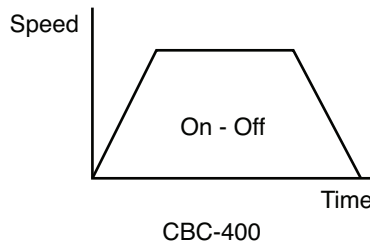
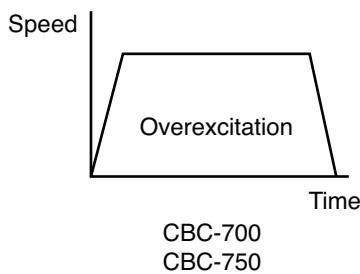

**Note:** Remove the brake autogap for best accuracy when soft stopping.

## Mode Of Operation (Program Line 8)

The CBC-1000 is programmable to operate in either the absolute or incremental mode of operation. Absolute mode is used in systems that tend to accumulate error. A common example is an indexing conveyor or table. When used in this mode, the CBC-1000 maintains its position in an absolute sense and compensates for any slight errors made on the prior move.

The incremental mode of operation is used for systems that will not accumulate error, such as a cut to length paper sheeter or an auger filler. In such systems, each consecutive move is independent of the previous one. In the incremental mode a reset signal to terminal 12 is required from one of the zero speed outputs or an external source (Ref. page 18 for wiring diagram). The key to mode selection is programming line 8, Auto Reset (on/off):

**Absolute** mode of operation - Auto Reset "On"  
**Incremental** mode of operation - Auto Reset "Off"

## Display Scaling (Program Line 3)

- Changing the CC & decimal point will affect presets
- CC should not exceed 1.0
- CC of .5 displays encoder pulses

The display can be easily scaled to display engineering units (inches, meters, degrees, rotations, etc). Line 3 of the programming (correction constant) prompts input of a factor (five decades) that will be multiplied by the incoming pulse train to display the desired engineering units. Remember that the CBC-1000 includes a times 2 internal multiplier effectively doubling the resolution of a given encoder. Thus, if one wishes to view encoder pulses, a multiplier (correction constant) of '0.5' should be entered on Line 3 in the programming mode. The resolution of the encoder should be chosen to take advantage of the best instantaneous accuracy of the calibrator. The best instantaneous accuracy is obtained with a correction constant setting not exceeding 1.0000. The scaled units are also used to measure stop and move distances. Consequently, the scaled units selected affect the system resolution. For example, with the correction constant set the display at 1.0 inches, this is the smallest measurable increment. Remember, the decimal point must be programmed (programming line 4) to display the desired display resolution. This resolution is also used in the denominator of the correction constant equation. The general form of the equation for the correction constant is given below.

$$\text{CC (Correction Constant)} = \frac{\text{Distance traveled in engineering units per one revolution of the encoder}}{\text{Display Resolution Desired} \times \text{Encoder Resolution} \times 2}$$

















(0.001, 0.01, 1.0)

Example:      Web measurement - Display in inches, display resolution in tenths of an inch  
                  Encoder Resolution - 600 PPR  
                  Mounting - Direct, via 4" diameter wheel

Calculation:

$$\text{CC} = \frac{\pi 0 = \pi \times 4 = 12.5664}{0.1 \times 600 \text{ pulses/revolution} \times 2} = 0.1047$$







## CBC-1000 Diagnostics Tests

- t 0: **Keyboard Test:** Tests the function of the front panel keys.  
Press  to begin test. RUN: will be displayed. Press each front panel key except  to test key. The display will indicate if the key is functional.
- t 1: **Non-Volatile RAM Test:** Tests CBC-1000 RAM.  
Press  to begin test. The test will return PASS or FAIL. Press  to continue.
- t 2: **Input Test:** Tests whether CBC-1000 is accepting inputs.  
Press  to begin test. Activate inputs to control.  
If the input is received, a character will be displayed. "Ab" - Encoder input, "1" - Start, "2" - Stop, "3" Continuous mode, "4" Reset. Press  to continue.
- t 3: **Output Test:** Used to determine whether CBC-1000 outputs are functional.  
Press  to begin test. Press keys 1-6 on the front panel. The corresponding output will turn on and latch. Use a VOM to check for a high level state on terminal strip of CBC-1000.  
Press  to exit test.
- t 4: **Display Test:** Tests function of each LED on front panel.  
Press  to begin test. Each digit of front panel display will automatically be turned on.  
Check for faulty LEDs. Press  to continue.
- t 5: **Program Memory Test:** Tests program memory capability.  
Press  to begin test. PASS or FAIL will be returned. Press  to continue.
- t 6: **Date Code Test:** Displays software date code.  
Press  to display date code. Press  to exit. Continue.
- t 7: **Serial Test:** Tests connections with serial data interface module.  
Press  to begin test. PASS or FAIL will be displayed. Press  to continue.
- t 8: **Factory Default Settings:** Returns CBC-1000 to factory settings.  
Press  to return all program steps to factory default settings.

# Programming

## View Presets and Values





The six function keys may all be viewed during the RUN mode. To view their values, press the desired function key and the value is displayed with the corresponding display annunciator. The controller process continues without interruption.

- Press  to display the current length or position (up to six digits).
- Press  to display the move preset (up to six digits).
- Press  to display the early warning preset (up to four digits).
- Press  to display the batch counter (up to six digits).
- Press  to display the batch counter preset (up to six digits).
- Press  to display the average braking distance (up to four digits).





## Entering Presets



The three presets (MOV PST, E.W., and BCH PST) may also be changed during the RUN mode provided that programming line 6 (panel lock) is programmed “off”. To edit, press the desired preset function key, next press the EDIT key followed by the CLEAR key. Enter the new value using the numeric keys, then press the EDIT key to exit the edit mode and to replace the existing value in memory. The CBC-1000 will use the new number entered after the edit mode is exited.



**Move Preset** Press  , then press  , and press  enter a new value using the numeric keys, then press  .

**Or** Press  , then press  , and press  or  to change the value incrementally. Then press  .

**Early Warning** Press  , then press  , and press  , now enter a new value using the numeric keys, then press  .

**Batch Preset** Press  , then press  , and press  , now enter a new value using the numeric keys, then press  .







**Batch Counter Reset** To manually reset the batch counter. Press  , then press  .

**System Home** To home the system: Press  then press  .



## Program Mode

To enter the program mode to access the 34 features shown on pages 12 and 13, press the program key and enter the 4-digit password (1000) followed by the down cursor. NOTE: Before entering the program mode, the stop key or stop input should be activated. The CBC-1000 automatically activates the brake upon entry into the program mode.

To enter the program mode:

Press , then press    , then press .

 Move down one program line

or press , then press line number, and press  to jump to the line changing.

 Move up one program line.

 Select Options.

To exit the program: Press .

## Latching Outputs

To latch the outputs or keep the outputs activated until a certain position is reached during the cycle, all zeros must be entered on programming lines 9-14 (shown on page 12). These latched outputs must be turned off at a predetermined function (programming lines 19-22) by a drop command. Outputs may be dropped at the Start command, Move Preset, Early Warning or Reset command. Press the front panel buttons (1-6) and a “d” will be displayed for the output to be dropped.

Example: Program Line 19 ----.----.----.----. d







Releases zero speed + delay 2 output at start command

Latching the batch counter reset, which is programming line 15, requires the operator to manually reset the batch counter (key 6) when it reaches the value programmed in the batch preset (key 7). By setting the batch counter reset to momentary (00.01 to 99.99 seconds), the CBC-1000 will automatically reset the batch counter and it will hold the batch complete output (pin 21) active for the time programmed.

## Programming

LINE	DISPLAY	DESCRIPTION	OPTIONS	DEFAULT	
1	b d .	Initial Braking Distance	- - - -	2 5	The first brake distance used by the CBC-1000 at power-up.
2	b d . Au E .	# of Cycles Averaged	1 - 9	3	The number of cycles used for the running average of brake distance.
3	c c .	Correction Constant	- . - - - -	0 . 5000	The scaling factor for the front panel display (0.5000 for display in pulses).
4	d P .	Decimal Point	off, .0, .00, .000	oFF	Number of decimal places displayed. Affects all distance values in other registers.
5	F r S t .	Front Panel Reset	on - off	on	Enables or disables front reset in the RUN Mode.
6	P L o c .	Front Panel Lock	on - off	oFF	"On" enables and "Off" disables changing MOV PST, E.W., and BCH PST while running.
7	C r E t .	Count Retention	on - off	on	Retains system position during power off.
8	A r S t .	AUTO Reset	on - off	oFF	Select Absolute (ON) or Incremental (OFF) mode of operation.
9	o 1 .	Start Output	00.00 to 99.99	00 . 10	The duration (momentary or latched) of the Start Output in seconds. For latched input, enter all zeros or press  .
10	o 2 .	Early Warning Output	00.00 to 99.99	00 . 10	The duration (momentary or latched) of the Early Warning output in seconds.
11	o 3 .	Brake on Output	00.00 to 99.99	00 . 10	The duration (momentary or latched) of the Brake On output in seconds.
12	o 4 .	Zero Speed Output	00.00 to 99.99	00 . 10	The duration (momentary or latched) of the Zero Speed output in seconds.
13	o 5 .	Zero Speed + Delay 1	00.00 to 99.99	00 . 10	The duration (momentary or latched) of the Zero Speed + Delay 1 output in seconds.
14	o 6 .	Zero Speed + Delay 2	00.00 to 99.99	00 . 10	The duration (momentary or latched) of the Zero Speed + Delay 2 output in seconds.
15	o 8 .	Batch Counter Reset	00.00 to 99.99	LATCH	Momentary for automatic (internal) reset or latched for manual (operator) reset.
16	d 1 .	Delay Time 1	00.00 to 99.99	0 . 50	The delay time for Zero Speed + Delay 1 output in seconds.
17	d 2 .	Delay Time 2	00.00 to 99.99	1 . 00	The delay time for Zero Speed + Delay 2 output in seconds.
18	0 5 P .	Zero Speed Window	.01, .05, .10, .25 sec.	. 10	The time window in seconds to determine Zero Speed, Zero Speed equals no pulses received within window.
19	5	Start Command Release	Outputs / .no change 1-6 / d .drop out	- - - - - .....	Releases latched outputs at the start command. Press 1-6 on the front panel to release or drop output.
20	L	Move Preset Release	Outputs / .no change 1-6 / d .drop out	- - - - - .....	Releases latched outputs at the move preset. Press 1-6 on the front panel to release output or drop output.

## Programming

LINE	DISPLAY	DESCRIPTION	OPTIONS	DEFAULT	
21	E	Early Warning Release	Outputs .no change 1-6 / d .drop out	----- .....	Releases latched outputs at the Early Warning signal. Press 1-6 on the front panel to release output or drop output.
22	r	Reset Command Release	Outputs .no change 1-6 / d .drop out	----- .....	Releases latched outputs at reset. Press 1-6 on the front panel to release output or drop output.
23	b r .	Baud Rate	off, 300, 600, 900 1200, 2400	oFF	See Serial Interface Section.
24	P A r	Parity	nonE, odd, EuEn	nonE	See Serial Interface Section.
25	i d . n o .	Identification Number	0 - 99	0	Control identification number. See Serial Interface Section. See Troubleshooting Section on page 25 for further information on diagnostic tests listed below.
26	t 0 .	Keyboard Test	rdy	y	Front panel keyboard test.
27	t 1 .	Non-Volatile RAM test	Press 	y	Non-Volatile RAM test.
28	t 2	Input Test	Ab - encoder inputs 1 - start 2 - stop 3 - cont. 4 reset	y	Refer to Diagnostics Test, Page 9
29	t 3	Output Test	1 - E	y	Control output test.
30	t 4	Display Test	Press 	y	Front panel display test.
31	t 5	Program Memory Test	Press 	y	Control program memory test.
32	t 6	Date Code Test	Press 	y	Displays Date Code of CBC-1000 software.
33	t 7	Serial Test	Press 	y	Control serial test.
34	t 8	Factory Default Settings	Press 	y	Returns control to factory default settings.

# Installation

## Connection Diagrams

### AC Input and Quadrature Encoder Input Wiring

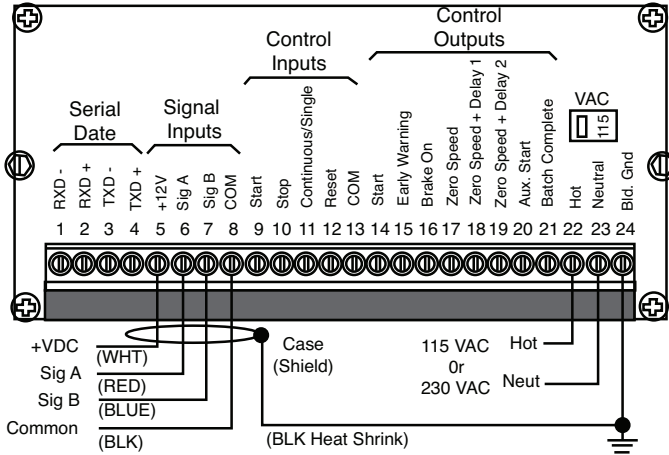

**Note:**

- 1) Set Selector switch for correct input voltage.
- 2) Unit is not fused. Wire through .25 AMP Slow Blow fuse.
- 3) The case shield should not be used when the encoder is mounted on a grounded surface.

### Start and Reset Input Wiring

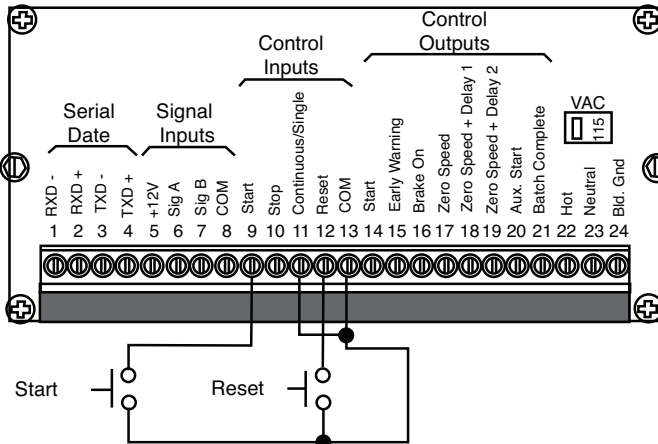

**Note:** the Start Input is enabled by connecting terminal 11 to terminal 13 (see below).

### Continuous/Single Input Wiring

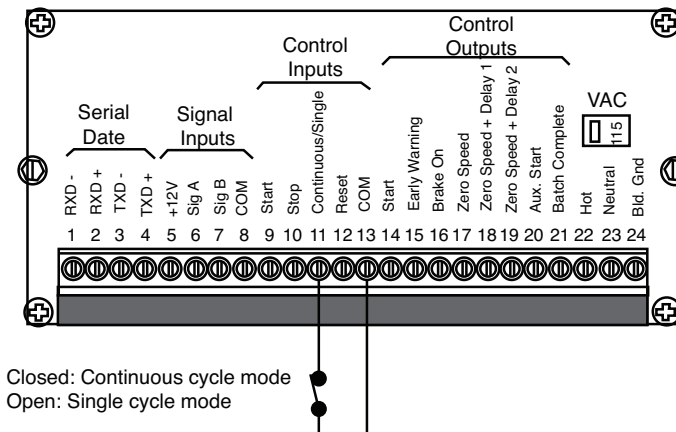

In the single cycle mode, the external start input is ignored. The front panel start key must be pressed to initiate the clutch.  
In the continuous mode, both the front panel start key and the external start input can be used to initiate the clutch.



# Installation

## Connection Diagrams

### Stop Wiring (E-Stop)

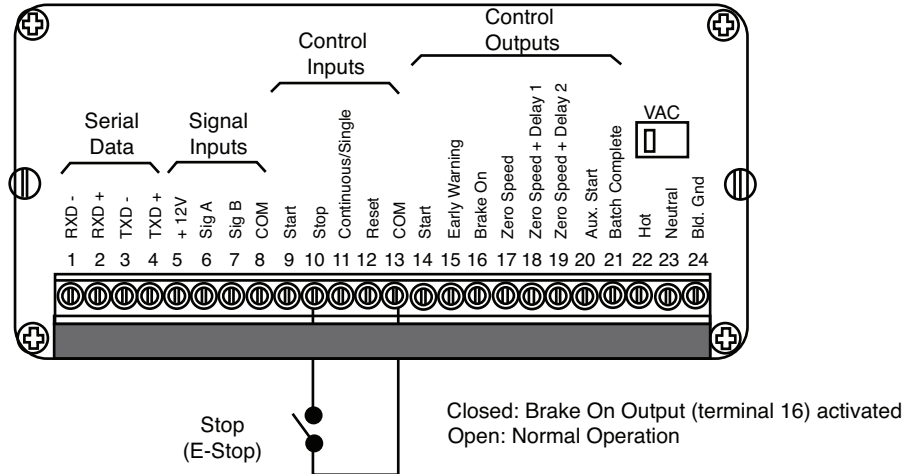

**Note:** A start input can not be executed when the switch is closed.

### Control Output (Outputs 1-8, Terminals 14-21) Wiring

Duration of output signal controlled by programming lines 10-17.

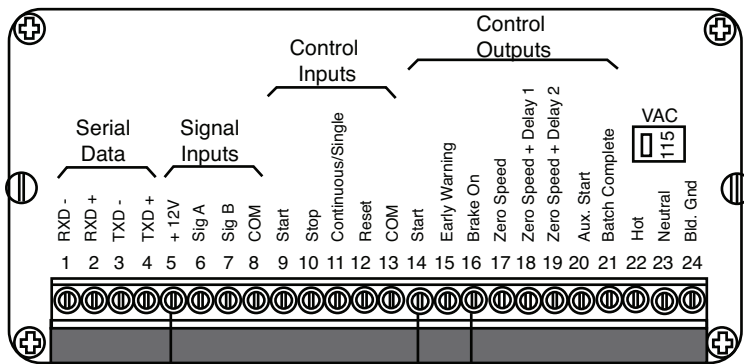

- Connect to brake Input terminal of the clutch/brake control (i.e. Terminal 6 on the CBC-700)
- Connect to clutch Input terminal of the clutch/brake control (i.e. Terminal 8 on the CBC-700)
- Connect to clutch and brake Input terminals of the clutch/brake control (i.e. Terminals 5 & 7 on the CBC-700)

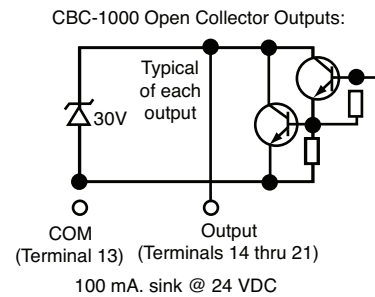

# Installation

## Connection Diagrams

### Delay Timer Used as a Cycle Timer

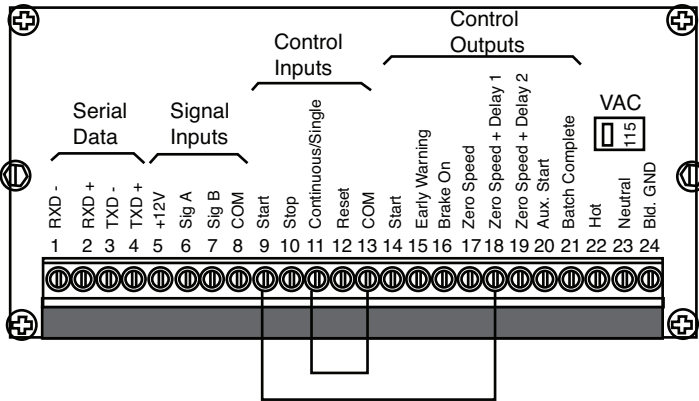

Delay Timers 1 or 2 may be used to initiate an external start input signal and function like a cycle timer. The delay times are programmed on lines 16 and 17 of the program mode. In the diagram, Delay Time 1 is used to initiate the external start input signal to begin the next operation.

**Note:** the CBC-1000 must be configured in the continuous mode as shown.

### Delay Timer Used to Reset the Count in the Incremental Mode of Operation

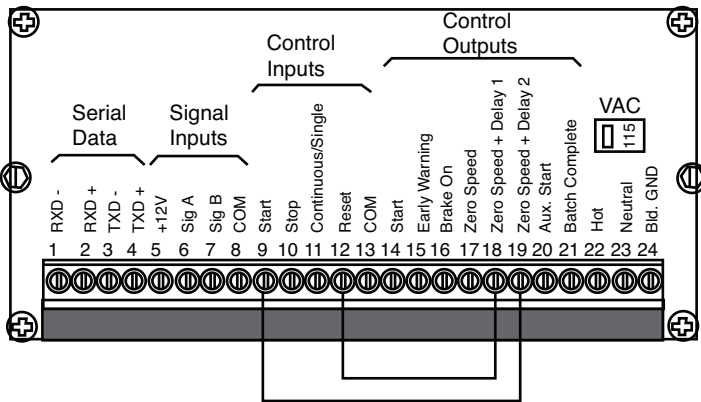

Output 4, 5 or 6 (Terminals 17, 18, 19) may be used to reset the counter in the incremental mode. Remember, in the incremental mode (programming line 8, auto Reset -"off") it is necessary to externally reset the counter at the completion of the previous operation. In the diagram, Delay Time 1 (programming line 16) is used to reset the counter, Delay Time 2 to start.

### Batch Complete Configured to Stop Operation after Batch Preset has been Reached

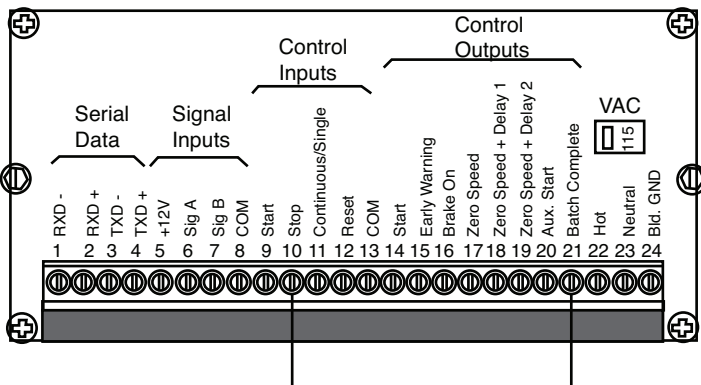

The Batch Complete Output may be used to stop operations after a preset batch count (programmed via function key 7, see page 10). Once this batch preset has been reached, it is necessary to reset the batch counter (function key 6, see page 10) to continue another batch. The batch counter can be reset manually or automatically by programming line 15 (refer to page 12).

# Installation

## With Auxiliary Power Supply (Rear View)

### Typical Sensor Wiring

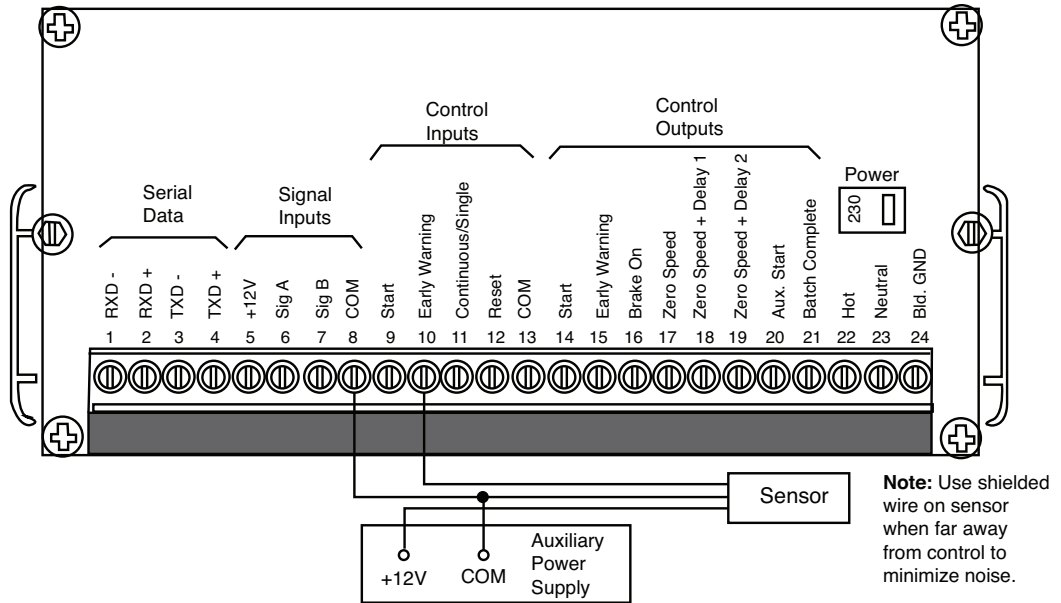

### Typical Relay Wiring

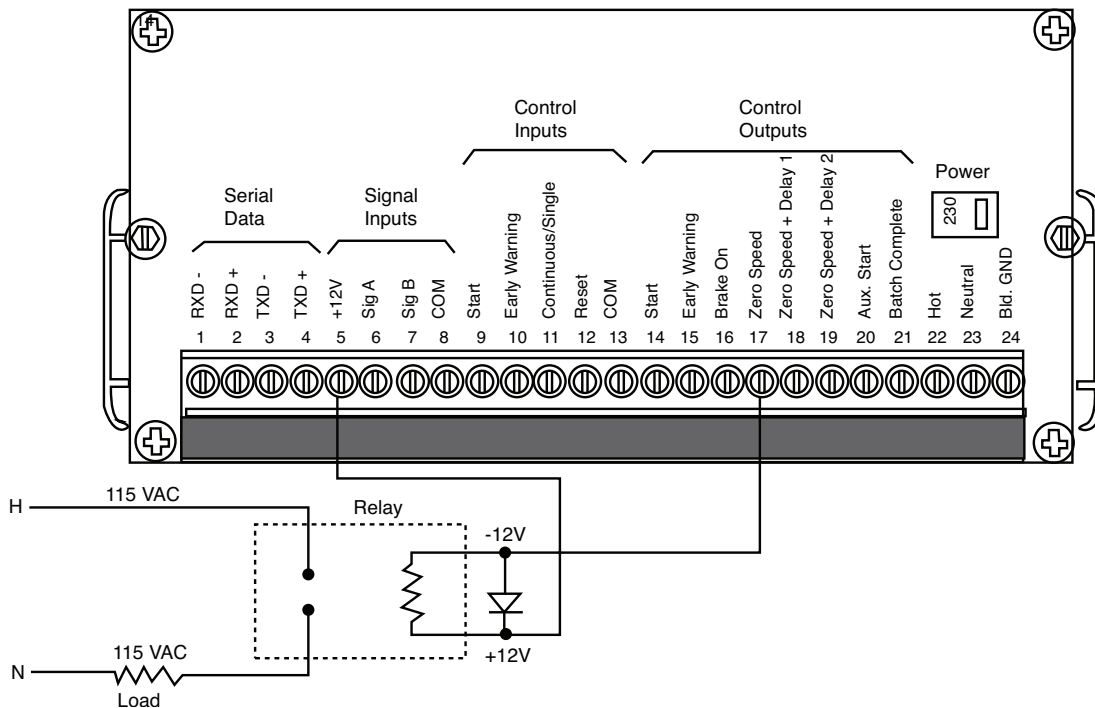

# Applications

## Absolute Mode of Operation

### NOTES:

1. Absolute mode requires Line 8 be "on" and that reset be used only to "home".
2. Continuous/Single switch used to stop machine at end of cycle when in open position. Closed position enables Start input, terminal 9 which will restart the machine.

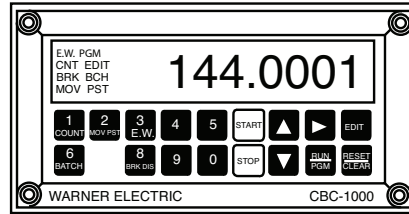

### Programming Table

Line 8 Auto Reset ON  
 Line 16 Delay Time 1.200

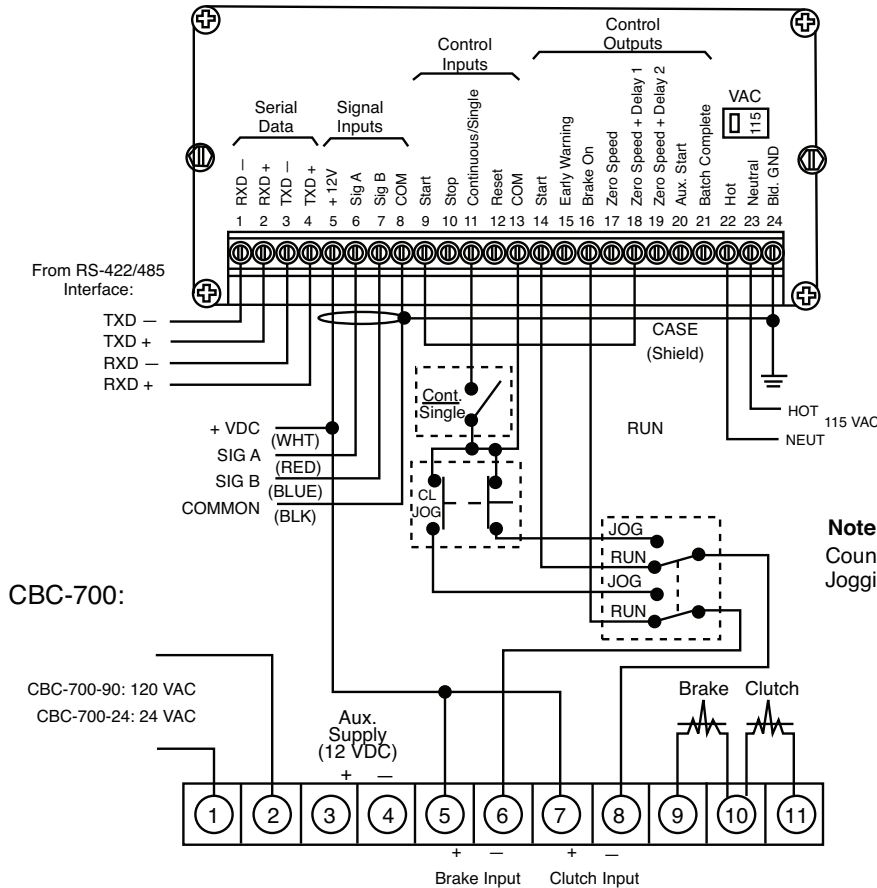

**Note:**  
 Case shield should not be used when the encoder is mounted on a grounded surface.

**Note:**  
 Counter must be reset after Jogging to a new home position.

# Applications

## Incremental Mode Of Operation

**NOTES:**

1. Incremental mode requires Reset before restarting. This may be achieved using outputs 5 or 6.

**CAUTION:** Machine may restart following key pad STOP. Continuous/Single Jumper enables external start input generated through Output 6, terminal 19. Keep single continuous switch open to disable the external start signal.

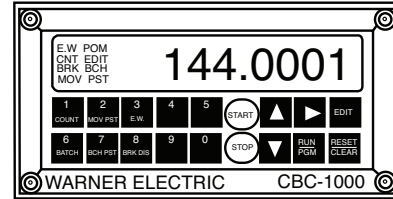

**Programming Table**

- Line 8 Auto Reset OFF
- Line 16 Delay Time 1.70
- Line 17 Delay Time 21.0

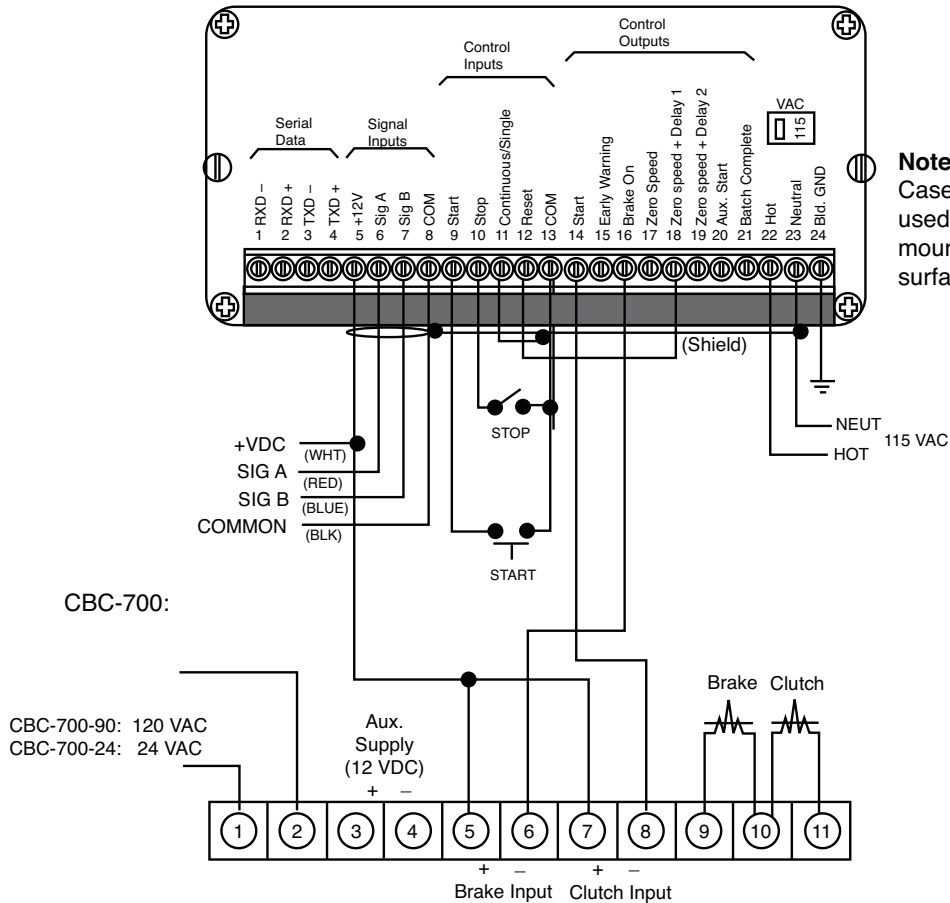

## Serial Interface

### Overview

The CBC-1000 is equipped with an RS-422A/485 Serial Interface for remote data collection, programming and networking applications. Front panel keyboard and some external control inputs are supported. Additionally, facilities are provided for individual (local) and group (global) control of single and multiple unit configurations respectively in a bus oriented system. Knowledge of serial communications and the ASCII data format is required by the user who wishes to use the remote capabilities or to integrate the control into a larger system.

Two applications will be discussed. The first consists of a single CBC-1000 and a display terminal. It explains the use of the serial commands that mimic the keyboard operation and some control inputs. An application of multiple units under the control of a host computer will also be discussed.

### Serial Connections

#### Single Unit Wiring

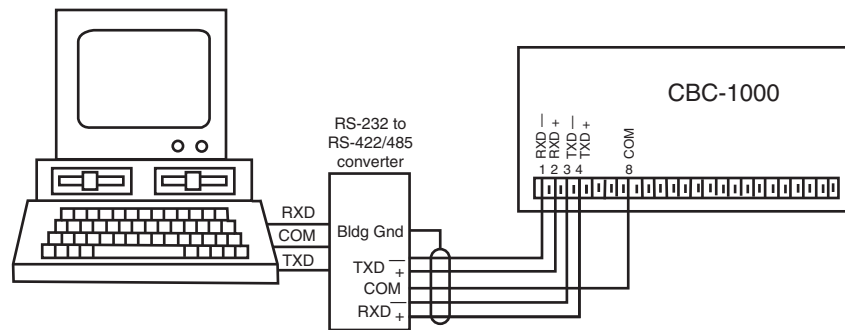

#### Multiple Unit Wiring

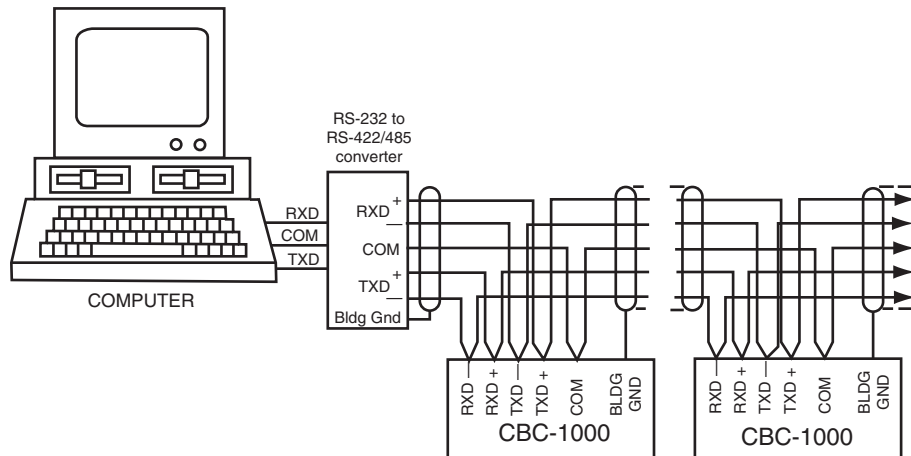

### Termination

The RS-422A/485 receivers require termination to minimize the effects of noise while the bus is not being driven. The CBC-1000 incorporates the terminations internally (as shown). When connection is made to an RS-422/485 device other than the CBC-1000, the receiver should be terminated as shown.

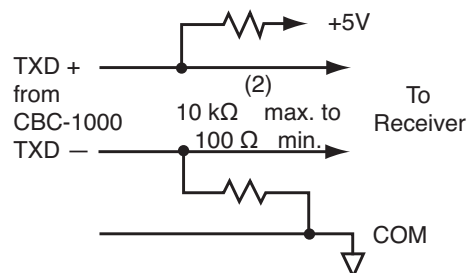

## Serial Interface

### Cable Selection

The CBC-1000 serial interface uses a simple interconnect scheme and low cost wiring making it superior to parallel data transfer schemes. Through three wire pairs, remote operation at distances up to 5,000 feet can be implemented. The following general guidelines should be observed:

1. Use #24 AWG Twisted pair, overall shielded cable.
2. Use a “daisy chained” connection scheme for bus systems.
3. if a “multidrop” system is used, keep the drop length at 10% of the main line.
4. Tie the cable shield to Building Ground at the CBC-1000 end of the cable.

### Single Unit Operation

The operator can monitor the control locally via the front panel keyboard and display. The serial interface extends these monitoring activities to a remote location. The connection of a remote display terminal is straightforward. The baud rate and parity for both devices must be the same. The ID number should be set to ‘0’ (line 25 in the program table).

When power is applied to the CBC-1000 control, it will start a continuous serial transmission of the count:

**CBC-1000 Display R: CNT. 123.456**

when in the RUN mode.

The function keys (1, 2, 3, 6, 7, & 8) are set to scroll down through the eight RUN modes lines.

For example:

Host	Mode	CBC-100	Display
1	R:	CNT	123.456
2	R:	MOV PST	11.50
3	R:	E.W.	0.25
6	R:	BCH	1500
7	R:	BCH PST	2500
8	R:	BRK DIS	0.25

In the RUN mode the numbers 1, 2, 3, 6, 7, & 8 cause new lines to be transmitted.

We have seen how the CBC-1000 control works for remote viewing; we will now see how programming may be done from a remote location.

You may program only one CBC-1000 control at a time. If the unit is in program mode via the front panel keyboard, then it will not respond to the serial input. To enter the PROGRAM mode, first send the RUN/PGM (‘P’) character. The control will “answer” by transmitting the LOC entry line as shown below.

Host	Mode	CBC-1000	Display
P	R:	LOC.	1

The control remains active (in the RUN mode) until the proper lock combination is entered. Each numeric entry is entered from right to left “calculator style”. The character sequence 1-0-0-0 would produce the following display on the terminal:

Host	Mode	CBC-1000	Display
1	R:	LOC.	1
0	R:	LOC.	10
0	R:	LOC.	100
0	R:	LOC.	1000

When this combination is correctly entered with a down cursor from the CBC-1000 keyboard or “D” from Host Terminal, the control exits the RUN mode and enters the PROGRAM mode and returns with the following:

Host	Mode	CBC-1000	Display
D	P:	bd.	25

Note that the PROGRAM (‘P’) prompt is now shown. You are at the top of the PROGRAM table (line 1) as shown on page 12. Once the PROGRAM mode has been entered it is possible to program any line in the table. Refer to the COMMAND CHARACTER table for the keyboard equivalent serial characters. A programming example is shown on page 23.

## Serial Interface

Host	Mode	CBC-1000	Display
C	P:	MOV PST	.000
4	P:	MOV PST	.004
5	P:	MOV PST	.045
6	P:	MOV PST	.456
7	P:	MOV PST	4.567
8	P:	MOV PST	45.678
9	P:	MOV PST	456.789

The first serial entry ('C') clears the data field for the current line. As can be seen in the COMMAND CHARACTER table, this character mimics the RESET/CLEAR key. Numeric data entry is self explanatory.

### Multiple Unit Operation

For multiple unit systems (up to 32 units) a special addressing scheme is implemented so no conflicts arise on the serial bus. Each unit is given a unique serial address (ID number entered on line 25). Such a system application is shown on page 20. All units are programmed with the same baud rate and parity. It is advised that the initial ID number programming be done before the units are bussed together.

To control one CBC-1000 in a bus oriented system the host must first address it by sending an ADDRESS COMMAND SEQUENCE. This is shown below.

host: (ESC) A nn (where nn is unit number 1 to 99)

This escape code sequence will suspend the transmission from all units including the one that is addressed. The addressed unit will respond to all subsequent commands while the other units just "listen" on their receive input and turn their transmit output off.

To receive data from an addressed unit the host sends it a command to resume transmission using the RESUME control character, (CTRL Q).

If you wish to suspend data data transmission you may do so by using the SUSPEND control character, (CTRL S).

In some cases the host may want to send many commands to a CBC-1000 control without waiting for responses. This may be done by first suspending transmission (CTRL S) then by requesting a single UPDATE.

host: (ESC) U

### Setup Mode Operation

The SETUP mode may be entered directly from the RUN mode by cursoring to the desired SETUP line (4-8) using the 'D' command character then sending the 'L' command character which mimics the KEY keyboard key. This action will place the control in the SETUP mode allowing the user to change the data in lines 3 through 8 in the program table. Serial entry into the SETUP mode has the same operational requirements and restrictions as if it were entered via the front panel keyboard. Refer to pages 6-8 for a complete operational description.

Preset setpoints are changed using the numeric RST/CLR and DOWN cursor keys. The SETUP mode is exited by sending another 'L' command character at which time the controls revert back to the RUN mode.

### Remote Operation

Some of the unit's CONTROL inputs are effectively duplicated by serial commands, so it is possible to implement a single or multiple unit system with remote capability. Such a system can be used for multiple machine, multiple axis or multiple section applications. Keep in mind the addressing requirements for multiple unit systems previously discussed.



## Serial Interface

Two types of commands are available, LOCAL and GLOBAL. LOCAL commands affect only the unit that is currently addressed. GLOBAL commands on the other hand affect all units regardless of address. In this way it is possible to command many units to begin control at the same point in time. The table below lists the LOCAL and GLOBAL commands that are supported.

LOCAL and GLOBAL COMMANDS			
Control Command	LOCAL	GLOBAL	Comments
Output Control	(ESC) LO	(ESC) GO	Simulates Output Control Input
Batch Reset	(ESC) LB	(ESC) GB	Resets Batch to Zero
Counter Reset	(ESC) LR	(ESC) GR	Reset Counter to Zero

## Formats and Protocol

### Character Format

The serial interface sends and receives information by characters consisting of 10 bits. The RS-422A/485 interface requires a 0.2V minimum differential across + and - terminals. A logic high (mark) is a positive differential and a logic low (space) is a negative differential. **(Note:** Connection to EIA-422/485 equipment that uses the opposite polarity requires swapping the + and - connections at the other equipment.)

The character format is as follows:

- Start bit (“low”) logic level)
- ASCII data (7 bits), least to most significant
- Parity bit (programmable)
- Stop bit (“high” logic level”)

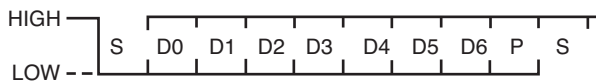

### Parity Bit (see note)

The parity bit is programmable as “Odd”, “Even”, or “No” parity. Odd and Even parity force the total number of data bits to be even or odd for data that is transmitted by the CBC-1000 control. Incoming parity is always compared to the calculated parity. Characters with parity errors are discarded. If No parity is selected incoming parity is ignored. Characters are transmitted with Odd or Even parity as selected on line 24 of the program table. If No parity is selected then “high” bit is added as an extra Stop bit.

### Baud Rate (see note)

Select the baud rate to match the device communicating with the control. You may select: 300, 600, 1200, or 2400 baud on line 23 of the program table. Gaud rate is common to both transmitter and receiver.

### Line Format

The CBC-1000 control transmits only complete lines. The driver is turned off when not transmitting causing the bus to enter a “float” state. Ignore data on the bus during this “float” time. Unless otherwise commanded, the CBC-1000 control continuously transmits the Count Value. The line format is as follows:

- a carriage return at the beginning of a line
- a prefix indicating RUN, SETUP, or PROGRAM
- a unique line mnemonic
- a five digit data field with decimal point
- a carriage return at the end of the line

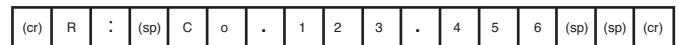

**Note:** To make changes in Parity or Baud Rate power must first be removed then reapplied after program changes to either are made. Both Parity and Baud Rate are initialized when the control “powers up”.

## Command Characters

Command Characters mimic the operation of the front panel keyboard. Below is a list of the serial equivalents of the front panel keys.

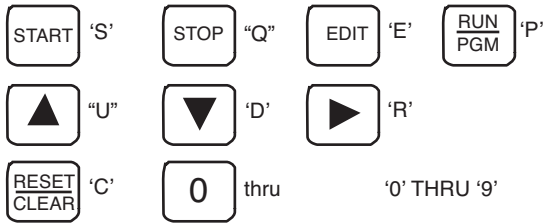

## Protocol

The CBC-1000 will “buffer” up to 16 Command and Control Characters (but not Escape Code Sequences) listed above, sent in “burst mode”.

Those characters are read, in order, every 20 msec. The protocol should be careful not to overflow the receive buffer. Additionally, Escape Code Sequences should not be sent until the buffer has emptied and all characters have been processed.

## Control Characters

Two control characters are used to start and stop the transmission from the CBC-1000 control. They are shown below:

(CTRL) S Suspends transmission following the completion of a line being sent. The driver will then be turned Off.

(CTRL) Q Resumes transmission from a unit that had been turned Off. The RUN mode line currently selected will be continuously updated.





## Escape Code Sequences

Escape code sequences are a group of special commands used for bus oriented systems. Every CBC-1000 control recognizes these commands. The two listed below are in addition to those listed in the table of LOCAL and GLOBAL commands.

(ESC) A nn The Address command is used to select a single control within a system. Only that unit whose serial I.D. number matches the two digit serial address (nn) will be selected. Only that unit will respond to subsequent serial commands. All units, even the addressed one, suspend transmission.

(ESC) U The Update command instructs the currently addressed unit to transmit a single line only.

## Troubleshooting

Problem	Solution
Machine starts but does not stop	Establish a move Preset Ensure brake functions properly using output test.
Display counts backwards	Reverse encoder A, B, wiring.
Machine stops but then restarts	Control may be responding to a start command. Check for transient signals. Use a Single/Continuous switch which disables the external start command.
System works well except for first cycle after power down	Monitor “Braking Distance” during successful operation, then program this value into “Initial Braking Distance” Line 1.
Control appears to function perfectly but the but the actual error is greater than the display indicates.	Check for slippage between the encoder and the manual items.
System accumulates error.	Change to Absolute Mode by programming Auto Reset (line 8) “on”. DO NOT use external reset except to home.
Control accumulates too many counts. Home zero position is drifting.	Check Display Scaling, page 8, and check for electrical noise, such as ground loops. Eliminate noise.
Control appears to work but proper motion is not occurring.	Review Clutch Brake and Control Service Manuals. Use Output Test (line 29) to verify performance.
System does not operate and fails diagnostic tests 1, 4, 5, or 7. Reference page 9.	Return unit for repair, call an Authorized Warner Electric Distributor.
System stops, but does not fire outputs.	Lower zero speed window (line 18) to minimize effects of encoder “bounce” caused by vibrations.
<b>Error Codes</b>	
If an error message appears	Disconnect power to CBC-1000 momentarily and error should clear. Press  to clear error code.
Error Code 2 - Low Line Voltage.	Correct line voltage. Press  to clear error code.
Error Code 3 - Feedback too fast.	Reduce encoder resolution and/or speed to keep encoder feedback less than 20,000 PPS. Press  to clear error code.
Error Code 4 - Process Time fully utilized	Reduce encoder resolution or consult factory. Press  to clear error code.

## Warranty

Warner Electric LLC warrants that it will repair or replace (whichever it deems advisable) any product manufactured and sold by it which proves to be defective in material or workmanship within a period of one (1) year from the date of original purchase for consumer, commercial or industrial use.

This warranty extends only to the original purchaser and is not transferable or assignable without Warner Electric LLC's prior consent.

Warranty service can be obtained in the U.S.A. by returning any defective product, transportation charges prepaid, to the appropriate Warner Electric LLC factory. Additional warranty information may be obtained by writing the Customer Satisfaction Department, Warner Electric LLC, 449 Gardner Street, South Beloit, Illinois 61080, or by calling 815-389-3771.

A purchase receipt or other proof of original purchase will be required before warranty service is rendered. If found defective under the terms of this warranty, repair or replacement will be made, without charge, together with a refund for transportation costs. If found not to be defective, you will be notified and, with your consent, the item will be repaired or replaced and returned to you at your expense.

This warranty covers normal use and does not cover damage or defect which results from alteration, accident, neglect, or improper installation, operation, or maintenance.

Some states do not allow limitation on how long an implied warranty lasts, so the above limitation may not apply to you.

Warner Electric LLC's obligation under this warranty is limited to the repair or replacement of the defective product and in no event shall Warner Electric LLC be liable for consequential, indirect, or incidental damages of any kind incurred by reason of the manufacture, sale or use of any defective product. Warner Electric LLC neither assumes nor authorizes any other person to give any other warranty or to assume any other obligation or liability on its behalf.

WITH RESPECT TO CONSUMER USE OF THE PRODUCT, ANY IMPLIED WARRANTIES WHICH THE CONSUMER MAY HAVE ARE LIMITED IN DURATION TO ONE YEAR FROM THE DATE OF ORIGINAL CONSUMER PURCHASE. WITH RESPECT TO COMMERCIAL AND INDUSTRIAL USES OF THE PRODUCT, THE FOREGOING WARRANTY IS IN LIEU OF AND EXCLUDES ALL OTHER WARRANTIES, WHETHER EXPRESSED OR IMPLIED BY OPERATION OF LAW OR OTHERWISE, INCLUDING, BUT NOT LIMITED TO, ANY IMPLIED WARRANTIES OF MERCHANTABILITY OR FITNESS.

Some states do not allow the exclusion or limitation of incidental or consequential damages, so the above limitation or exclusion may not apply to you. This warranty gives you specific legal rights and you may also have other rights which vary from state to state.

### Changes in Dimensions and Specifications

All dimensions and specifications shown in Warner Electric catalogs are subject to change without notice. Weights do not include weight of boxing for shipment. Certified prints will be furnished without charge on request to Warner Electric.



**Warner Electric LLC**  
449 Gardner Street • South Beloit, IL 61080  
815-389-3771 • Fax: 815-389-2582  
www.warnerelectric.com  
**An Altra Industrial Motion Company**